

Stami

Studiopepe
2022



Desk e vanity con cassetti laterali con base in frassino curvato tinto nero a poro aperto e dettagli in ottone lucido. Struttura in legno con rivestimento in pelle o pelle scamosciata nei colori del campionario. Piano apribile a ribalta in legno tinto nero poro aperto e vano interno dotato di sottomano in pelle o pelle scamosciata coordinata con il rivestimento esterno. Piano a ribalta con lavagna magnetica (desk) o con specchio (vanity).

Per la realizzazione di elementi con rivestimento in pelle sono necessarie cuciture aggiuntive.

Cm (L x P x H)

140 x 60 x 76

65 x 34 x 2

Inches (L x P x H)

55¼ x 23¾ x 30

25¾ x 13½ x 1

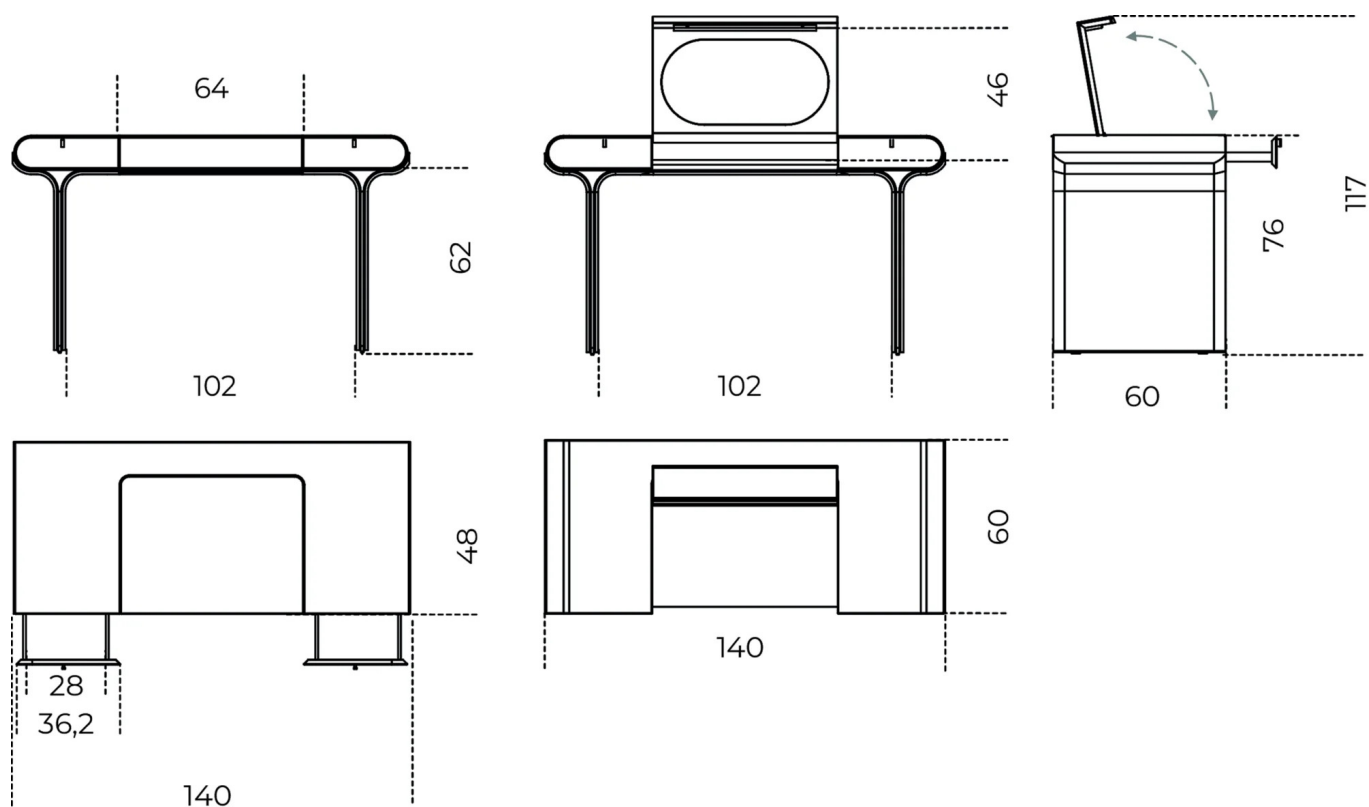

Finiture

Legno



Frassino tinto nero a
poro aperto

Metallo

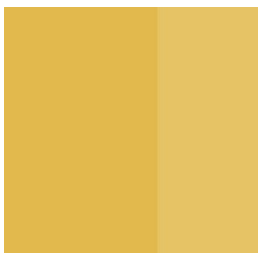

Ottone lucido

Pelle Cat.L1



Fard amber 2343

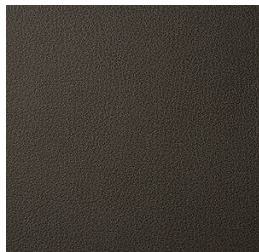

Fard anthracite 2379



Fard clay 2303



Fard deer 2346

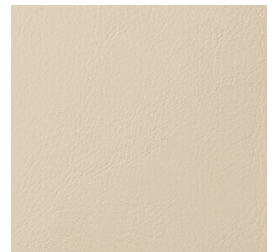

Fard ecru 2304



Fard loden green 2357

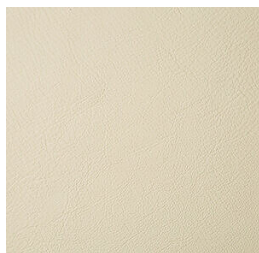

Fard milk 2300



Fard nude 2334



Fard otter 2348



Fard silt 2324

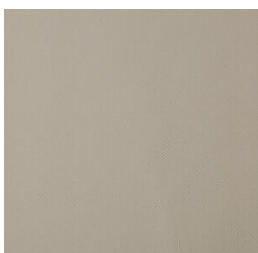

Fard silver 2302

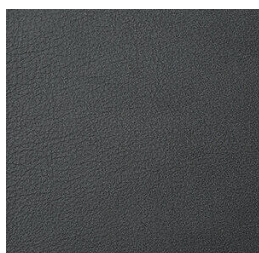

Fard slate 2386



Fard tan 2305



Soft amber 004

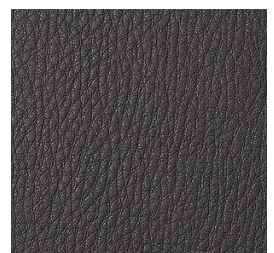

Soft anthracite 005



Soft clay 002



Soft deer 003



Soft ecru 001

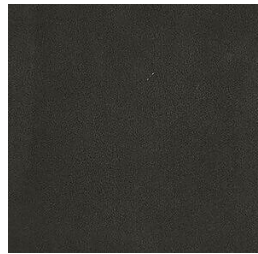

Suede grey 020

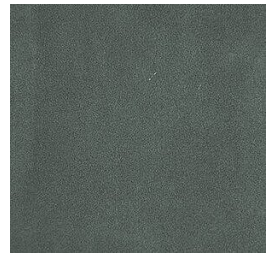

Suede grey 058

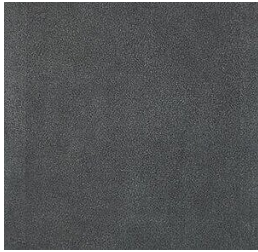

Suede grey 074

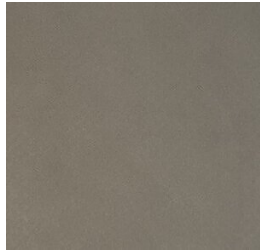

Suede sand 006

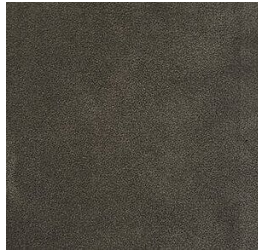

Suede sand 012

Pelle Cat.L2



Leather black 001



Leather clay 008



Leather milk 010



Leather rose powder 012

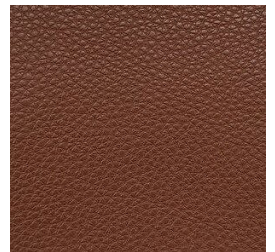

Leather tobacco 013

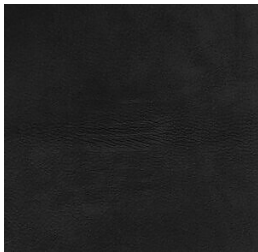

Nabuk black 2138



Nabuk blue 2117



Nabuk cement 2115